

Sustavi za praćenje i vođenje procesa

Branko Jeren i Predrag Pale

Fakultet elektrotehnike i računarstva
Zavod za elektroničke sustave i obradbu informacija

B. Jeren i P. Pale: Sustavi za praćenje i vođenje procesa LAN © 1991.-2016.



Lokalne računalne mreže

LAN
Local Area Network

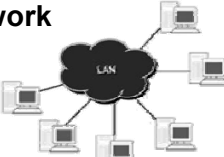

B. Jeren i P. Pale: Sustavi za praćenje i vođenje procesa LAN © 1991.-2016.

Što su lokalne računalne mreže ?



- **zemljopisno su omeđene**
 - jedna zgrada (soba)
 - ili skupina zgrada u dometu vidljivosti ("campus")
- **jedan vlasnik**
- brzine prijenosa podataka **10 Mbps** i veće
 - iako neki smatraju da je već i 2 Mbps dovoljno



B. Jeren i P. Pale: Sustavi za praćenje i vođenje procesa LAN © 1991.-2016.

Što je IEEE 802 ?

- *Institute of Electrical and Electronic Engineers*



- **skupina standarda za lokalne računalne mreže (LAN)**
 - 802.1 - uvod
 - 802.2 - gornji dio Data Link Layer-a (LLC)
 - 802.3 - CSMA/CD (Ethernet)
 - 802.4 - Token Bus
 - 802.5 - Token Ring

B.Jeren | P.Pale: Sustavi za praćenje i vođenje procesa

LAN © 1991.-2016.

IEEE 802.1	Bridging (networking) and Network Management
IEEE 802.2	Logical link control
IEEE 802.3	Ethernet
IEEE 802.4	Token bus
IEEE 802.5	Defines the MAC layer for a Token Ring
IEEE 802.6	Metropolitan Area Networks
IEEE 802.7	Broadband LAN using Coaxial Cable
IEEE 802.8	Fiber Optic TAG
IEEE 802.9	Integrated Services LAN
IEEE 802.10	Interoperable LAN Security
IEEE 802.11	Wireless LAN & Mesh (Wi-Fi certification)
IEEE 802.12	demand priority
IEEE 802.13	
IEEE 802.14	Cable modems
IEEE 802.15	Wireless PAN
IEEE 802.15.1	Bluetooth certification
IEEE 802.15.4	ZigBee certification
IEEE 802.16	Broadband Wireless Access (WiMAX certification)
IEEE 802.16e	(Mobile) Broadband Wireless Access
IEEE 802.16.1	Local Multipoint Distribution Service
IEEE 802.17	Resilient packet ring
IEEE 802.18	Radio Regulatory TAG
IEEE 802.19	Coexistence TAG
IEEE 802.20	Mobile Broadband Wireless Access
IEEE 802.21	Media Independent Handoff
IEEE 802.22	Wireless Regional Area Network

B.Jeren | P.Pale: Sustavi za praćenje i vođenje procesa

LAN © 1991.-2016.

IEEE 802.3

B.Jeren | P.Pale: Sustavi za praćenje i vođenje procesa

LAN © 1991.-2016.

802.3 - CSMA/CD

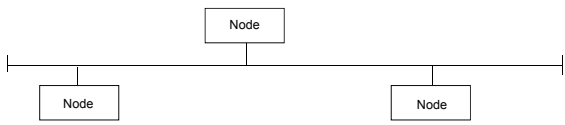

- sabirnica
- **C**arrier **S**ense **M**ultiple **A**ccess with **C**ollision **D**etection
- **Ethernet** je samo jedna primjena (proizvod) 802.3
- standard definira
 - medij
 - konektore
 - električke karakteristike
 - protokol
 - format podataka

B.Jeren | P.Pale: Sustavi za praćenje i vođenje procesa LAN © 1991.-2016.

802.3 - kako radi ?

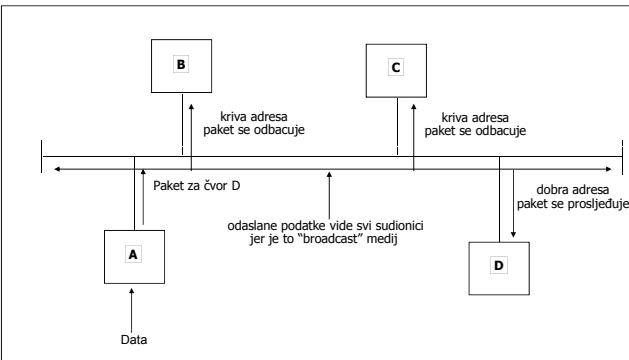

B.Jeren | P.Pale: Sustavi za praćenje i vođenje procesa LAN © 1991.-2016.

802.3 - kako radi ?

- primanje
 - **osluškujem** medij i primam **sve poruke**
 - gledam **adresu** u poruci
 - ako **nije** za mene, **odbacim**
 - ako **je** za mene, **proslijedim**
 - višim razinama softvera
- slanje
 - **osluškujem** da li je medij **slobodan**
 - čim **jest**, **šaljem**
 - dok šaljem, slušam priča li još i netko drugi
 - ako priča, prestanem slati i zagalamim
 - čekam slučajni iznos vremena i krenem od početka

B.Jeren | P.Pale: Sustavi za praćenje i vođenje procesa LAN © 1991.-2016.

802.3 - mediji i konektori

• izvorno je definiran koaksijalni kabel

- "debeli", "žuti"
- "tanki", "radioamaterski"

• danas se uglavnom koristi

- upletena parica, twisted pair (TP)
 - oklopljena (STP)
 - neoklopljena (UTP)
 - "foil" (FTP)
- svjetlovod

Naziv	Tanki koaksijalni	Debeli koaksijalni	Neoklopljena parica	Svjetlovod
Tip žice	RG-8	RG-58	22 - 26 AWG	62.5/125 micron
IEEE Naziv	10BASE5	10BASE2	10BASET	10BASEF
Oznaka standarda	IEEE 802.3	IEEE 802.3a	IEEE 802.3i	N/A
druge oznake	"tanki mreža"	"debeli mreža"	UTP	

B.Jeren i P.Pale: Sustavi za praćenje i vođenje procesa

LAN © 1991-2016.

802.3 - koaksijalni kabel

• izvorno je definiran koaksijalni kabel

- 50 Ohma
- zaključenje na oba kraja

• dvije izvedbe

- 802.3: "debeli", "žuti"
 - "vampire-tap"
 - 500 m segment
- 802.3a: "tanki", "radioamaterski"
 - BNC konektor
 - 185 m segment

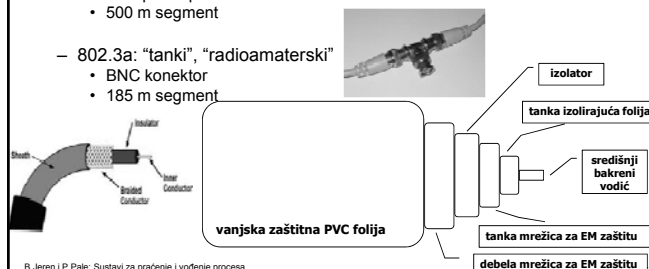
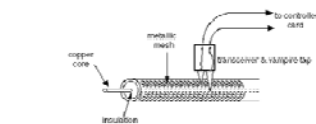

B.Jeren i P.Pale: Sustavi za praćenje i vođenje procesa

LAN © 1991-2016.

802.3 - električke karakteristike

- 80 mA (na 25 Ohm) = -2V
- naponsko sjedilo 100 kOhm
- spajanje segmenata preko "repeater-a"
 - restauracija signala
- uređaji se na kabel spajaju preko "transceiver-a"

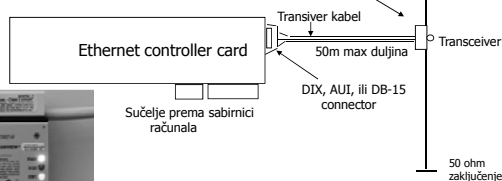

Sučelje prema sabimici računala

B.Jeren i P.Pale: Sustavi za praćenje i vođenje procesa

LAN © 1991-2016.

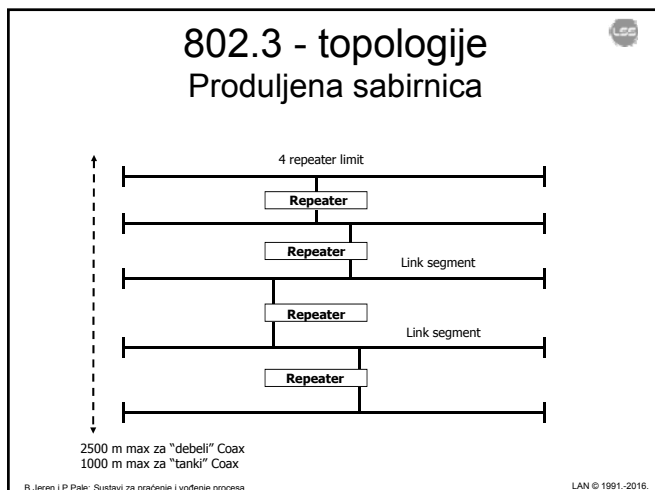

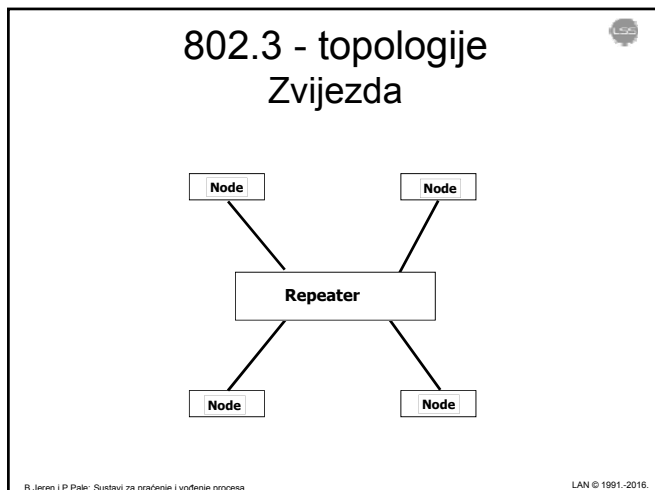

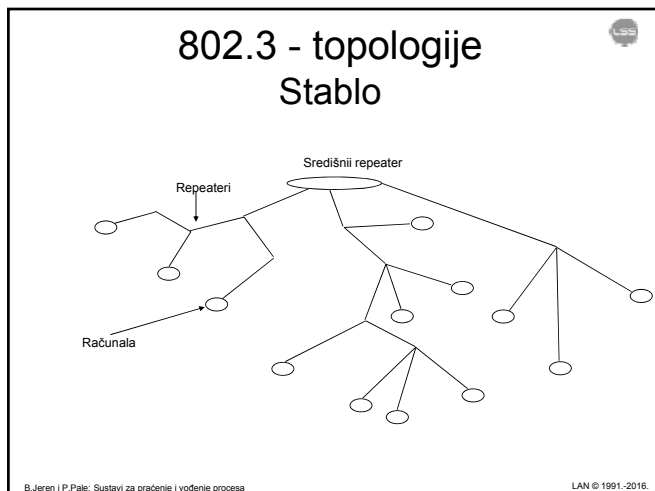

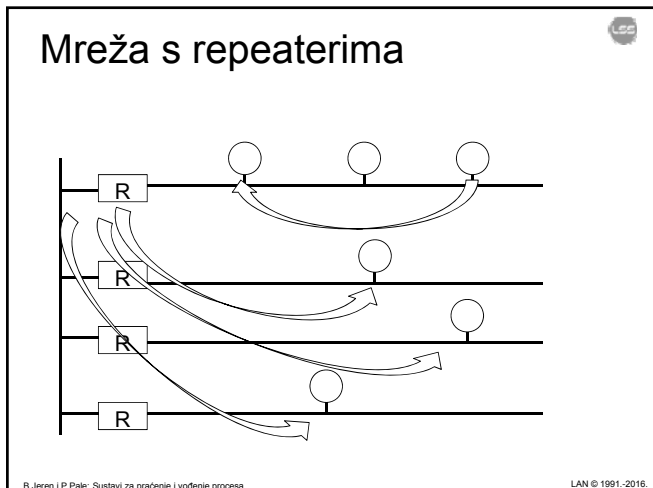

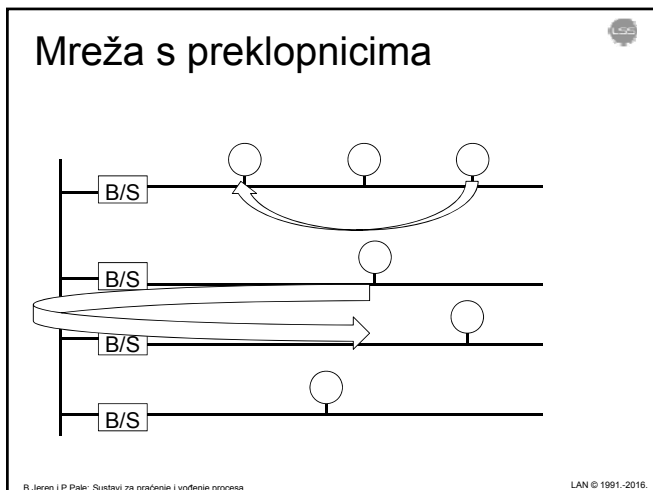

Hub, repeater, switch

- HUB
 - spojište, koncentrador
 - u praksi se koristi za repeater
 - ali i za switch
- Repeater
 - električki pojačava signal
 - s jednog prosljeđuje na sve ostale priključke (eng. port)
- Switch
 - čita cijeli paket
 - ponovno ga šalje
 - samo na onaj port kojem je namijenjen
 - povećanje efektivnog prijenosnog kapaciteta

HUB Shared

SWITCH Dedicated

B.Jeren i P.Pale: Sustavi za praćenje i vođenje procesa LAN © 1991.-2016.

802.3 - format paketa

MAC layer header OSI layers 3 - 7 headers and data MAC trailer

Preamble	Destination address	Source address	Type field	Data field	CRC-32
----------	---------------------	----------------	------------	------------	--------

- **MAC – Media Access and Control**
 - opći naziv za OSI Layer 2
 - odnosi se na više tehnologija
 - Ethernet, TokenRing, ...

B.Jeren | P.Pale: Sustavi za praćenje i vođenje procesa LAN © 1991.-2016.

802.3 - format paketa

7 bytes	1 byte	6 bytes	6 bytes	2 bytes	1 byte	1 byte	1 or 2 bytes < 1496 bytes	4 bytes
Preamble	Start of Frame Delimiter	Destination address	Source address	Length field	Destination Service Access Point (DSAP)	Source Service Access Point (SSAP)	Control fields	Data Pad FCS

Destination Address

Byte 0	Byte 1	Byte 5
Bit 7	Bit 0	
Transmitted first		

Source Address

Byte 0	Byte 1	Byte 5
Bit 7	Bit 0	
Transmitted first		

B.Jeren | P.Pale: Sustavi za praćenje i vođenje procesa LAN © 1991.-2016.

802.3 prednosti i nedostaci

- **prednosti**
 - **nema kontrolera**, svi su **ravnopravni**
 - **jednostavno** uključivanje i isključivanje
 - visoka **učinkovitost** prijenosa
 - velika **raširenost**
 - niska cijena
 - jednostavna primjena
- **nedostaci**
 - **nema potvrde** prijenosa
 - eng. *unreliable transport*
 - **nedeterministički** odziv
 - **nema prioritete**
 - jedna vrsta prometa, jedan korisnik
 - **može zauzeti cijeli resurs**

B.Jeren | P.Pale: Sustavi za praćenje i vođenje procesa LAN © 1991.-2016.



Token Bus

IEEE 802.4

B.Jeren i P.Pale: Sustavi za praćenje i vođenje procesa LAN © 1991.-2016.

802.4 Token Bus

- sabirnica za industriju
- potreba za **determinističkim odzivom**
- potreba za linijskom topologijom: **sabirnica**
- potreba za prijenosom i drugih informacija
- definiran u General Motors



B.Jeren i P.Pale: Sustavi za praćenje i vođenje procesa LAN © 1991.-2016.

802.4 ideja prstena

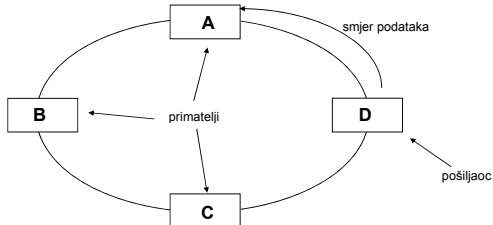

- **nadzor nad komunikacijom se ciklički prenosi** uvijek istim redoslijedom

B.Jeren i P.Pale: Sustavi za praćenje i vođenje procesa LAN © 1991.-2016.

802.4 kabel i modulacija

- koaksijalni **75 Ohma** (TV)
- amplitudna modulacija (TV)
- frekvencijski multipleks
 - video i audio signali u ostalim kanalima
- definirane brzine prijenosa:
 - 1, 5, i 10 Mbps

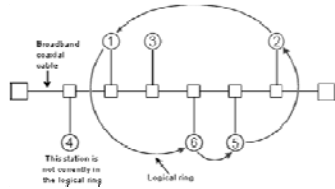

B.Jeren i P.Pale: Sustavi za praćenje i vođenje procesa

LAN © 1991.-2016.

802.4 signali

- modulacija omogućava prenošenje više signala (simbola):
 - "0" i "1"
 - slobodno
 - tri simbola za kontrolu
- fizički sloj nekompatibilan s 802.3

B.Jeren i P.Pale: Sustavi za praćenje i vođenje procesa

LAN © 1991.-2016.

802.4 problemi protokola

- uključivanje
 - čeka da bude prozvana
 - ako ih je više, slijedi "aukcija"
- isključivanje
 - mora se odjaviti
 - bdije i onaj tko je predao token
- "zadržani" token
 - štoperice
 - aukcija

B.Jeren i P.Pale: Sustavi za praćenje i vođenje procesa

LAN © 1991.-2016.

802.4 prednosti i nedostaci

- **prednosti**
 - fizička sabirnica
 - jedan medij za mrežu, audio i video
 - determinizam
 - jeftini medij
- **nedostaci**
 - složeni SW
 - mala rasprostranjenost
 - skup
 - teško se primjenjuje



B.Jeren | P.Pale: Sustavi za praćenje i vođenje procesa LAN © 1991.-2016.

Token Ring

IEEE 802.5

B.Jeren | P.Pale: Sustavi za praćenje i vođenje procesa LAN © 1991.-2016.

802.5 Token Ring

- potreba za **determinističkim odzivom**
- **prstenasta** topologija
 - point-to-point veze
 - **nepostojanje broadcast medija**
 - sustav je broadcast
- **digitalni** prijenos



B.Jeren | P.Pale: Sustavi za praćenje i vođenje procesa LAN © 1991.-2016.

802.5 ideja prstena

• **podaci se ciklički prenose kroz stanice**

B.Jeren | P.Pale: Sustavi za praćenje i vođenje procesa LAN © 1991.-2016.

802.5 povezivanje

- **point-to-point veze**
 - svaka stanica je povezana s dvije susjedne
 - digitalne veze
- standard propisuje **oklopljenu paricu**
- konektori
- brzine prijenosa 4 i **16 (1989.) Mbps**
- stanica mora **osigurati fizički prospoj** ako ne radi
- moguća **zvjezdasta konfiguracija**
 - putem "wire center-a" (Multistation Access Unit)

B.Jeren | P.Pale: Sustavi za praćenje i vođenje procesa LAN © 1991.-2016.

802.5 kabeli

- standard propisuje oklopljenu paricu
- mogu se koristiti i:
 - neoklopljena parica (4 ili 8 žica)
 - svjetlovod
- kategorija 3 za 4 Mbps
- kategorija 4 za 16 Mbps
- preporučena **max. udaljenost 100 m**

B.Jeren | P.Pale: Sustavi za praćenje i vođenje procesa LAN © 1991.-2016.

802.5 konektori

- Universal Data Connector (UDC) za STP
- RJ-11 za UTP
- RJ-45 ili DB-9



B.Jeren | P.Pale: Sustavi za praćenje i vođenje procesa LAN © 1991.-2016.

802.5 povezivanje

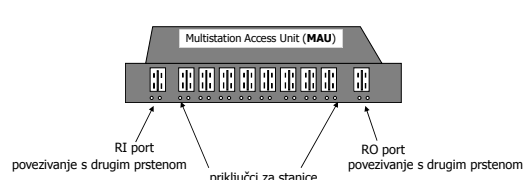

- **zvjezdasto**, preko središnjeg uređaja
- max. udaljenost za stanice je **100 m**

B.Jeren | P.Pale: Sustavi za praćenje i vođenje procesa LAN © 1991.-2016.

802.5 povezivanje

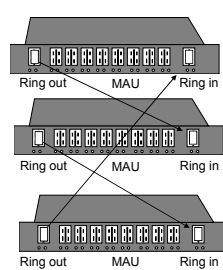

- moguće je više prstenova spojiti zajedno
- max. je 260 stanica

B.Jeren | P.Pale: Sustavi za praćenje i vođenje procesa LAN © 1991.-2016.

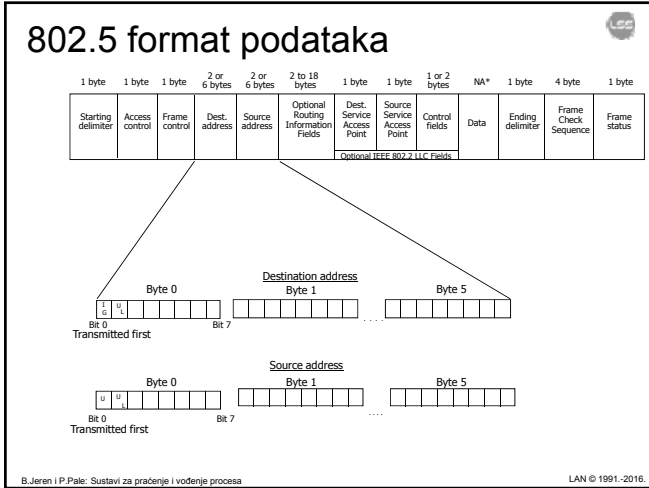

802.5 prednosti i nedostaci

- prednosti
 - ima potvrdu prijensa
 - eng. *reliable transport*
 - deterministički odziv
- nedostaci
 - koristi dio resursa čak i kad drugi nemaju što slati
 - manja učinkovitost prijensa
 - mala raširenost
 - skuplji od 802.3
 - teža primjena

B.Jeren | P.Pale: Sustavi za praćenje i vođenje procesa LAN © 1991.-2016.

FDDI

Fiber Distributed Digital Interface

B.Jeren | P.Pale: Sustavi za praćenje i vođenje procesa LAN © 1991.-2016.

FDDI

- Fiber Data Distributed Interface
- **prstenasta** topologija
 - dva prstena
 - DAS i SAS stanice
- 500 - 1000 stanica
- **100 Mbps**
- fiber (singlemode, multimode)
- **2 - 20 km**

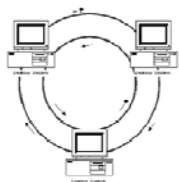

B.Jeren | P.Pale: Sustavi za praćenje i vođenje procesa

LAN © 1991.-2016.

FDDI ideja prstena

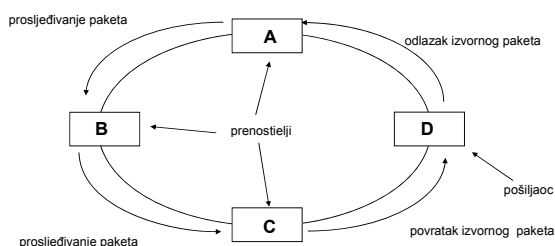

- **podaci se ciklički prenose kroz stanice**

B.Jeren | P.Pale: Sustavi za praćenje i vođenje procesa

LAN © 1991.-2016.

FDDI povezivanje

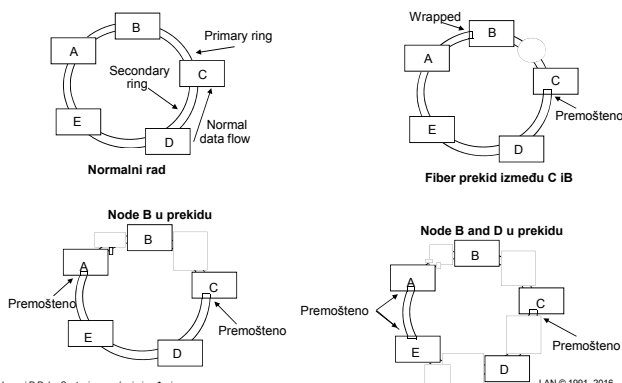

B.Jeren | P.Pale: Sustavi za praćenje i vođenje procesa

LAN © 1991.-2016.



**Sustavi za
praćenje i vođenje procesa**

SPVP.zesoi.fer.hr

B.Jeren i P.Pale: Sustavi za praćenje i vođenje procesa LAN © 1991-2016
